

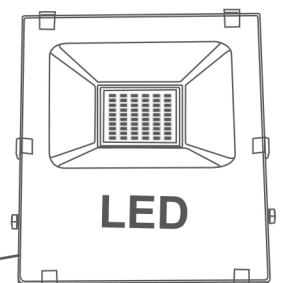

太阳能灯 SOLAR LIGHT

众享阳光 能惠万家

产品手册 | Product Catalogue





Vmpower 公司正式成立于北京
Multifit formally established in Beijing

2009-2012

首台逆变器研制成功
The 1st Inverter

网站: <https://multifitele.en.alibaba.com>
首台离网纯正弦波逆变器研发成功
并远销尼日利亚市场

进入意大利市场
Enter the Italian market

公司全方位布局国外展会及网络销售渠道,并一举进入意大利市场,签下几百万定单

研发产品远销欧洲
The 1st combiner box

首台太阳能汇流箱研制成功
并远销欧洲市场

出口国家首超50个
Exporting countries 50⁺

2013年产品出口国家首次超过50个

2013-2015

首次参加慕尼黑光伏展
Munich exhibition

2014年首次参加全球影响力最大的德国慕尼黑太阳能光伏展

光伏系统并入国家电网
Photovoltaic system

全面布局太阳能光伏发电系统工程的设计与安装

公司简介 | Company Profile

北京众能力电科技有限公司是一家致力于太阳能发电等绿色能源的研发、生产、销售和光伏电站建设服务的高新技术企业，公司总部位于中国北京。现有子公司广东众能光伏设备有限公司，厂房面积2000平，生产基地位于广东汕头高新技术开发区内。

公司专注于逆变电源、太阳能清洗机器人、太阳能户用电源、汇流箱、太阳能控制器、新能源发电设备、分布式电源、光伏跟踪支架及其配套产品的技术研制、生产、销售、服务、安装、系统集成及技术转让；太阳能路灯照明系统，太阳能灯箱及户外广告牌，LED照明及其它能源产品的研发、生产及销售；五金机电产品加工及销售；电力电子设备、电子、电器元件、电气传动及控制设备、成套配电电气、不间断电源、储能电源的研制、生产及销售；太阳能发电系统项目及电气自动化项目的设计与上门安装维护，新能源发电工程的设计、开发、投资、建设和经营；电源电气光伏技术及软件开发和转让；太阳能设备及光伏组件销售；合同能源管理；承装、承修、承试供电设施和受电设施，安防、机电工程安装，城市及道路照明工程施工；经营货物、技术与服务进出口业务。

自2009年成立以来，公司专注于提供全球一流的民用小型光伏电站解决方案及新能源电气产品的创新研发，培育了一批有理想、有经验、有技术的销售和研发团队。产品现已批量出口到法国、英国、意大利、澳大利亚，亚非拉等世界五十多个国家及地区，满足了国内外各不同地区及客户的需求及认可，持续提升客户的满意度及认知度。

未来，公司将秉承“高效节能，让更多人享用绿色能源”的发展使命，立足于光伏产业，努力将公司打造成为受人尊敬的一流光伏发电企业。

Beijing Multifit Electrical Technology Co., Ltd. is a high-tech plant for the solar power and renewable energy research, production, sales and construction of photovoltaic power station. We located in the Chinese capital, the center of the Beijing Economic and Technological Development Zone areas - a beautiful high-tech Fortune 500 companies Industry park.

Multifit group's main products in Beijing plant are Power inverter, Solar Panel Cleaning Robot, PV combiner box, Solar controller, LED, Solar light, Solar modules, solar and wind power generation systems; we have another branch plants Multifit Solar in Guangdong province for the production of the solar cleaning robot, solar charger, solar portable light, solar water heater, UPS, Batteries, Solar Pump Inverter, transformers etc. we undertake the projects related to electrical engineering design and installation and also our companies is in strict accordance with the ISO9001: 2008 quality system, some products has the TUV, UL, CE, SONCAP, CCC and other international authoritative certification and national quality inspection certification, and the patents.

Founded in 2009, the company focused on providing world-class small-scale photovoltaic power plants for civilian solutions and innovative research and development of renewable energy electrical products. we had cultivated a group of ideals, experience, technical sales and R & D team. Our products are now exported to France, UK, Italy, Hungary, Australia, Yemen, Pakistan, India, Nigeria, Dakar, Ghana, Chile, Dominican Republic, Asia and Africa and Latin America. There are more than 50 countries and regions in the world, and meet the various needs of different regions' customers. we never stop to try our best to grow up and enhance the customer's satisfaction and awareness.

Multifit name means to fit all your needs, step electric energy technological mountain on new heights! The technological tie will be used to send to you and to reach a higher level quality of life.

Future, Multifit is committed to improving the renewable energy industry, and continues to develop more efficient and cost-effective solar solutions to bring more green electricity into our lives.

高新技术企业认证
High-tech enterprise certification
2016年获得中关村高新技术企业认证

2016-2018

MULTIFIT 入驻广东
Guangdong Multifit established

众能广东工厂成立,并通过ISO9001体系认证,公司发展进入全新阶段
网站: <http://multifitsolar.com>

华侨版挂牌成功
Stock code: 280768

助力国家光伏扶贫,美丽乡村建设,并在
华侨版资本市场成功挂牌
股权代码: 280768

战略合作伙伴
Strategic partners with
CIDC Shantou University

2019-2021

获得国家高新技术企业认证,与汕头大学长江工业设计中心展开全方位合作。

清洗机器人G1诞生
The solar panel cleaning robot G1 was born
全智能第二代光伏清洗机器人诞生,并获得发明专利一项,实用新型专利三项

Welcome to MULTIFIT



目录 | Catalogue

太阳能庭院灯 | Solar Garden Light 01

太阳能路灯 | Solar Street Light 03

太阳能人体感应路灯 | Solar Integrated Light 06

太阳能监控路灯 | Solar Integrated Light CCTV 11

太阳能投光灯 | Solar Flood Light 13

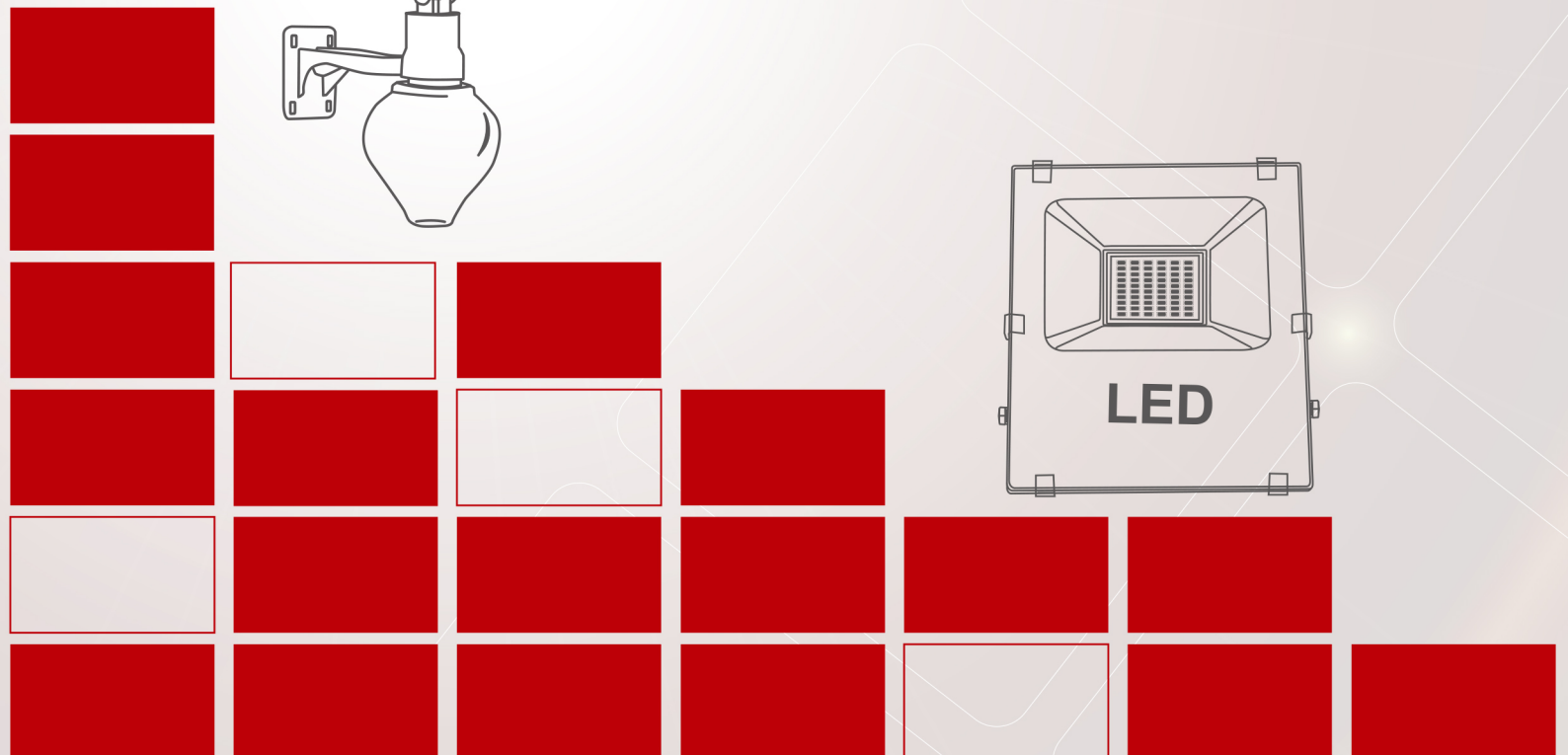
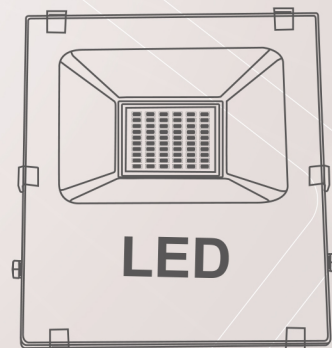
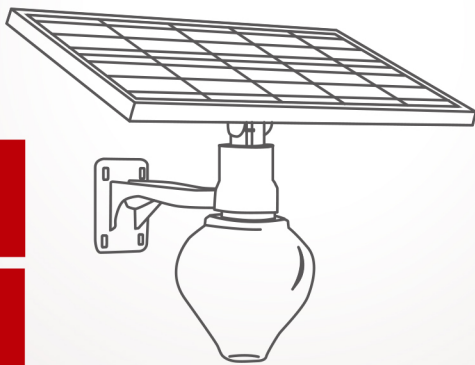

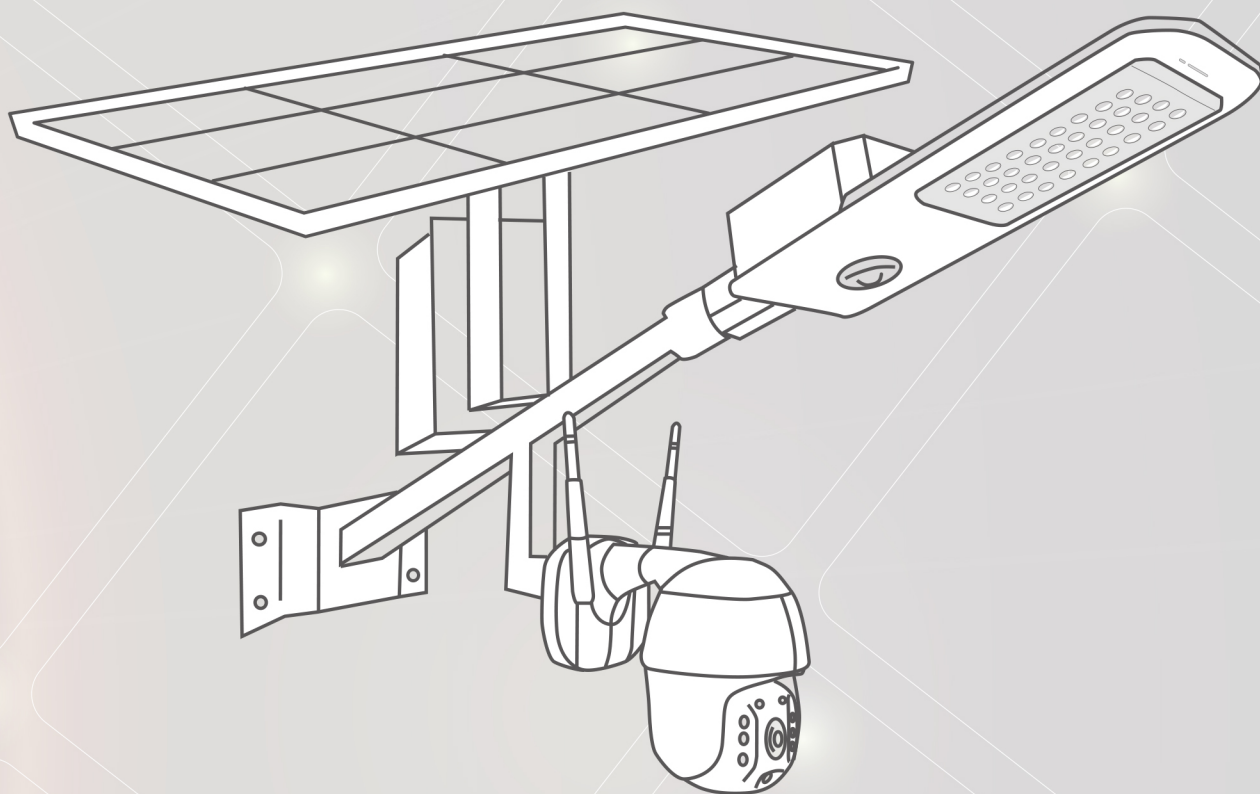

太阳能庭院灯案例 | Solar Garden Light Project **15**

太阳能路灯案例 | Solar Street Light Project **16**

太阳能人体感应路灯案例 | Solar Integrated Light Project **17**

太阳能监控路灯案例 | Solar Integrated Light CCTV Project **19**

太阳能投光灯案例 | Solar Flood Light Project **20**

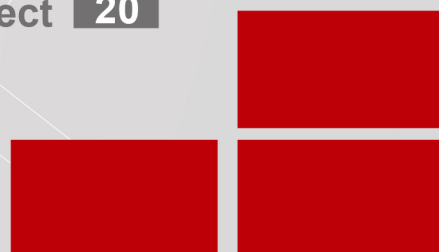

太阳能庭院灯 | Solar Garden Light

产品特点:

- 1.无线应用 - 将太阳能电池板, 控制器, 电池和LED灯组合在一起。
- 2.外形设计 - 美观现代, 简约时尚。
- 3.智能遥控 - 六种工作模式: 灯光控制, 时间, 微波控制, 时间和微波, 演示 (ON) 和关闭。
- 4.太阳能电池板可调 - 可在垂直和水平方向上调节, 确保最大的太阳能转换效率。
- 5.微电脑控制 - 完美结合运动传感器系统, 光控系统和时间控制系统, 确保整个系统更节能。
- 6.锂电池 - 采用LifePO4电池取代传统凝胶电池, 使用寿命更长。
- 7.模块化设计 - 所有组件均采用模块化设计, 并采用标准化生产。







Product characteristic:

- 1.Wireless application--Combined solar panel, controller, battery and LED lights into all in one.
- 2.Appearance design--Beautiful and modern appearance, simple and stylish.
- 3.Smart remote control--six working mode: light control, time, microwave control, timeµwave, demo(ON) and OFF.
- 4.Solar panel adjustable-Adjustable in vertical and horizontal direction, ensure maximum efficiency of solar energy conversion.
- 5.Micro-computer controlled-Combine motion sensor system, light control system and time control system perfectly, ensure whole system more energy-efficient.
- 6.Lithium battery-Adopt LifePO4 battery to replace traditional gel battery, longer lifetime.
- 7.Modular design-All components are modular design and in standardized production.



产品参数 Technical Data:

图片 Picture	内容 Content
	<p>型号: MUL-ZL001 光源: 12PCS瑞丰光电5730 电池板: 6V/10W/1.66A 功率: 6W 电池: 磷酸铁锂电池 3.2V 电池容量: 8AH 充电时间: 4-6H 照明时间: 可持续照明12小时 电池板尺寸: 350mm*235mm 伸臂长度: 300mm 单个包装尺寸: 51*36*40.5CM/3.4KG 双个包装尺寸: 51*49*35CM/6.89KG</p>
	<p>Model: MUL-ZL001 Light source: 12PCS Ruifeng Photoelectric 5730 Battery board: 6V/10W/1.66A Power: 6W Battery: Lithium iron phosphate battery 3.2V Battery capacity: 8AH Charging time: 4-6H Lighting time: 12 hours of sustainable lighting Panel size: 350mm*235mm Arm length: 300mm Individual package size: 51*36*40.5CM/3.4KG Double package size: 51*49*35CM/6.89KG</p>

图片 Picture	内容 Content
<div style="display: flex; justify-content: space-around;"> <div style="text-align: center;">  <p>苹果款 Apple type</p> </div> <div style="text-align: center;">  <p>桃子款 Peach type</p> </div> </div>	<div style="display: flex; justify-content: space-between;"> <div style="width: 48%;"> <p>型号: MUL-ZL002 光源: 18PCS瑞丰光电5730 电池板: 6V/15W/2.5A 功率: 9W 电 池: 磷酸铁锂电池 3.2V 电池容量: 12AH 充电时间: 4-6H 照明时间: 可持续照明12小时 电池板尺寸: 370mm*305mm 伸臂长度: 300mm 单个包装尺寸: 51*36*40.5CM/4.5KG 双个包装尺寸: 51*49*35CM/8.49KG</p> </div> <div style="width: 48%;"> <p>Model: MUL-ZL002 Light source: 18PCS Ruifeng Photoelectric 5730 Battery board: 6V/15W/2.5A Power: 9W Battery: Lithium iron phosphate battery 3.2V Battery capacity: 12AH Charging time: 4-6H Lighting time: 12 hours of sustainable lighting Panel size: 370mm*305mm Arm length: 300mm Individual package size: 51*36*40.5CM/4.5KG Double package size: 51*49*35CM/8.49KG</p> </div> </div>
<div style="display: flex; justify-content: space-around;"> <div style="text-align: center;">  <p>苹果款 Apple type</p> </div> <div style="text-align: center;">  <p>桃子款 Peach type</p> </div> </div>	<div style="display: flex; justify-content: space-between;"> <div style="width: 48%;"> <p>型号: MUL-ZL003 光源: 24PCS瑞丰光电5730 电池板: 6V/18W/3A 功率: 12W 电 池: 磷酸铁锂电池 3.2V 电池容量: 15AH 充电时间: 4-6H 照明时间: 可持续照明12小时 电池板尺寸: 420mm*370mm 伸臂长度: 300mm 单个包装尺寸: 51*36*40.5CM/5.2KG 双个包装尺寸: 51*49*35CM/9.6KG</p> </div> <div style="width: 48%;"> <p>Model: MUL-ZL003 Light source: 24PCS Ruifeng Photoelectric 5730 Panel: 6V/18W/3A Power: 12W Battery: Lithium iron phosphate battery 3.2V Battery capacity: 15AH Charging time: 4-6H Lighting time: 12 hours of sustainable lighting Panel size: 420mm*370mm Arm length: 300mm Individual package size: 51*36*40.5CM/5.2KG Double package size: 51*49*35CM/9.6KG</p> </div> </div>
<div style="display: flex; justify-content: space-around;"> <div style="text-align: center;">  <p>苹果款 Apple type</p> </div> <div style="text-align: center;">  <p>桃子款 Peach type</p> </div> </div>	<div style="display: flex; justify-content: space-between;"> <div style="width: 48%;"> <p>型号: MUL-ZL004 光源: 32PCS瑞丰光电5730 电池板: 6V/25W/4A 功率: 15W 电 池: 磷酸铁锂电池 3.2V 电池容量: 18AH 充电时间: 4-6H 照明时间: 可持续照明12小时 电池板尺寸: 500mm*350mm 伸臂长度: 300mm 单个包装尺寸: 51*36*40.5CM/5.5KG 双个包装尺寸: 61*31*41CM/11.6KG</p> </div> <div style="width: 48%;"> <p>Model: MUL-ZL004 Light source: 32PCS Ruifeng Photoelectric 5730 Battery board: 6V/25W/4A Power: 15W Battery: Lithium iron phosphate battery 3.2V Battery capacity: 18AH Charging time: 4-6H Lighting time: 12 hours of sustainable lighting Panel size: 500mm*350mm Arm length: 300mm Individual package size: 51*36*40.5CM/5.5KG Double package size: 61*31*41CM/11.6KG</p> </div> </div>

360°无死角旋转
360° no dead angle rotation

加厚铝材支架
The thick aluminum bracket is firm and stable

户外抗紫外线PMMA灯罩
Outdoor anti-UV, PMMA lampshade.





太阳能路灯 | Solar Street Light

产品特点:

- 1.智能光感启动，无需人工操作：白天太阳能板吸收阳光储蓄电池，晚上环境变暗则自动亮灯；
- 2.防护等级达到IP65：防水，防尘，防晒，延长使用寿命
- 3.加厚铝合金框架：抗摔，防锈，防腐蚀，更耐用；
- 4.超高流明光源：亮度高，发光均匀，散热好，寿命长；
- 5.大容量锂电池：13200毫安，充满电的情况下，可持续照明；
- 6.单晶太阳能板：高效率充电，3-5小时充满电池。

Product characteristic:

1. Intelligent light sense start, no manual operation: solar panels absorb sunlight to save battery during the day, and automatically light up when the environment becomes dark at night.
2. Protection level reaches IP65: waterproof, dustproof, sunscreen, prolonged service life.
3. Thick aluminum frame: anti-fall, anti-rust, anti-corrosion, more durable.
4. Ultra-high lumen light source: high brightness, uniform illumination, good heat dissipation and long life.
5. Large capacity lithium battery: 13200 mAh, fully charged, Sustainable lighting.
6. Monocrystalline solar panel: high efficiency charging, full battery for 3-5 hours.

产品参数 Technical Data:



超高流明光源 散热好

Ultra-high lumen light source for good heat dissipation.



铝灯体散热快

The aluminum lamp body dissipates heat quickly.



加厚铝材支架 牢固稳定

The thick aluminum bracket is firm and stable.



高防护不漏电

High protection does not leak electricity.

图片 Picture	内容 Content
	<p>型号:MUL-0112-1 产品材质: 铝灯体 充电时间: 6-7小时 时间设置: 8+1小时 保质期: 1年 光源贴片: LED/15W 太阳能板: 10V/8W 电池: 7.4V/5000mAh 灯头的重量尺寸: 320*150mm/3kg 支架的重量尺寸: 500mm/1.6kg 太阳能板重量尺寸: 350*350mm/1.3kg</p>
	<p>型号:MUL-0124-1 产品材质: 铝灯体 充电时间: 6-7小时 时间设置: 8+1小时 保质期: 1年 光源贴片: LED/24W 太阳能板: 10V/12W 电池: 7.4V/10000mAh 灯头的重量尺寸: 320*150mm/3kg 支架的重量尺寸: 500mm/1.6kg 太阳能板重量尺寸: 350*350mm/1.3kg</p>
	<p>型号:MUL-0136-1 产品材质: 铝灯体 充电时间: 6-7小时 时间设置: 8+1小时 保质期: 1年 光源贴片: LED/36W 太阳能板: 10V/15W 电池: 7.4V/12000mAh 灯头的重量尺寸: 320*150mm/3kg 支架的重量尺寸: 500mm/1.6kg 太阳能板重量尺寸: 350*350mm/1.3kg</p>

太阳能路灯 | Solar Street Light

产品特点:

1. 智能数字控制系统 (高效节能) 电池寿命长.大容量锂电池。
2. 高品质LED灯珠: 大功率输出, 高亮度照明, 照明更均匀
3. 多晶硅太阳能电池板: 高效的多晶硅太阳能电池板, 可在弱光环境下缩短充电时间并提高充电效率。
4. 大容量锂电池: 持续点亮时间长达20小时
5. IP65防水等级智能防雷芯片, 产品通过防水测试, 持久防锈。
6. 光学控制+遥控器+定时 (自动灯光控制模式-遥控模式)

Product characteristic:

1. Intelligent digital control system (high efficiency/energy saving) battery Long life. large capacity lithium battery.
2. High quality LED lamp beads :High-power output, high-brightness illumination, more uniform illumination.
3. Polycrystalline solar panel: High-efficiency polycrystalline solar panels for shorter charging times and higher charging efficiency in low-light environments It can also be charged in rainy weather.
4. Hight capacity lithium battery: Continuous lighting time up to 20 hours.
5. IP65 waterproof grade intelligent lightning protection chip, long-lasting anti-rust paint process(Pass waterproofing test).
6. Optical control+remote control +timing
Automatic light control mode-remote control mode.

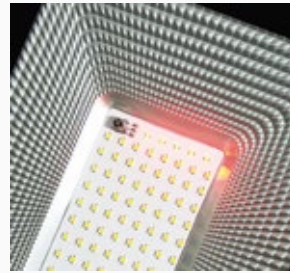

超高流明光源 散热好

Ultra-high lumen light source for good heat dissipation.



铝灯体散热快

The aluminum lamp body dissipates heat quickly.



加厚铝材支架 牢固稳定

The thick aluminum bracket is firm and stable.

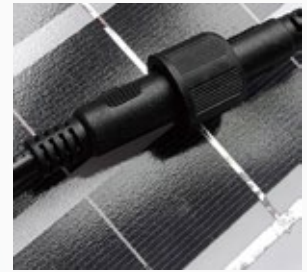

高防护不漏电

High protection does not leak electricity.



Six luminous surfaces

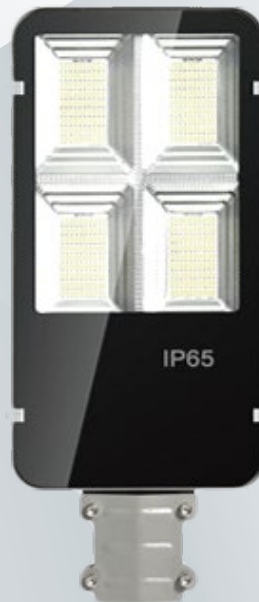

Four luminous surfaces



Two luminous surfaces

产品参数 Technical Data:

<p>图片 Picture</p>	<p>内容 Content</p>	
	<p>型号:MUL-ZN50 功率: 50W 产品材质: 高温烤漆主铸铝灯体, 钢化玻璃面板 光源贴片: LED 灯珠数量: 98颗5730 充电时间: 6-10小时 满电时长: 20个小时 照射面积: 50㎡ 保质期: 1年 太阳能板: 6V/15W 电池: 3.2V2节 12000mAh 1.2M对接线 (1.0平方) 灯头的重量尺寸: 500*210*50mm 太阳能板重量尺寸: 350*350mm</p>	<p>Model: MUL-ZN50 Power: 50W Material:Aluminum body, tempered glass panel Light source: LED Lamp beads number: 98 pcs 5730 Charging time:6-10hours Full battery time: 20 hours Irradiation area:50 m² Solar panel:6V/15W Battery:3.2V 2 12000mAh 1.2m wiring cable(1 m²) Lamp head Size:500*210*50mm Solar panel Size:350*350mm Warranty: 1year</p>
	<p>型号:MUL-ZN100 功率: 100W 产品材质: 高温烤漆主铸铝灯体, 钢化玻璃面板 光源贴片: LED 灯珠数量: 207颗5730 充电时间: 6-10小时 满电时长: 20个小时 照射面积: 80㎡ 保质期: 1年 太阳能板: 6V/20W 电池: 3.2V3节 18000mAh 1.2M对接线 (1.0平方) 灯头的尺寸: 500*210*50mm 太阳能板尺寸: 460*350mm</p>	<p>Model: MUL-ZN100 Power: 100W Material:Aluminum body, tempered glass panel Light source: LED Lamp beads number: 207 pcs 5730 Charging time:6-10hours Full battery time: 20 hours Irradiation area:80 m² Solar panel: 6V/20W Battery:3.2V*3 18000mAh 1.2m wiring cable(1 m²) Lamp head Size:500*210*50mm Solar panel Size:460*350mm Warranty: 1year</p>
	<p>型号:MUL-ZN150 功率: 150W 产品材质: 高温烤漆主铸铝灯体, 钢化玻璃面板 光源贴片: LED 灯珠数量: 299颗5730 充电时间: 6-10小时 满电时长: 20个小时 照射面积: 100㎡ 保质期: 1年 太阳能板: 6V/20W 电池: 3.2V4节 24000mAh 1.2M对接线 (1.0平方) 灯头的尺寸: 500*210*50mm 太阳能板尺寸: 460*350mm</p>	<p>Model: MUL-ZN150 Power: 150W Material:Aluminum body, tempered glass panel Light source: LED Lamp beads number: 299 pcs 5730 Charging time:6-10hours Full battery time: 20 hours Irradiation area:100 m² Solar panel:6V/20W Battery:3.2V*4 24000mAh 1.2m wiring cable(1 m²) Lamp head Size:500*210*50mm Solar panel Size:460*350mm Warranty: 1year</p>
	<p>型号:MUL-ZN200 功率: 200W 产品材质: 高温烤漆主铸铝灯体, 钢化玻璃面板 光源贴片: LED 灯珠数量: 358颗5730 充电时间: 6-10小时 满电时长: 20个小时 照射面积: 120㎡ 保质期: 1年 太阳能板: 6V 30W 电池: 3.2V6节 36000mAh 1.2M对接线 (1.0平方) 灯头的尺寸: 500*210*80mm 太阳能板尺寸: 600*350mm</p>	<p>Model: MUL-ZN200 Power: 200W Material:Aluminum body, tempered glass panel Light source: LED Lamp beads number: 358 pcs 5730 Charging time:6-10hours Full battery time: 20 hours Irradiation area:120 m² Solar panel:16V 15W Battery:3.2V*6 36000mAh 1.2m wiring cable(1 m²) Lamp head Size:500*210*80mm Solar panel Size: 600*350mm Warranty: 1year</p>
	<p>型号:MUL-ZN50A 功率: 50W 产品材质: 高温烤漆主铸铝灯体, 钢化玻璃面板 光源贴片: LED 灯珠数量: 50颗3030 充电时间: 6-10小时 满电时长: 36个小时 照射面积: 120㎡ 保质期: 1年 太阳能板: 6V 30W 电池: 6.4V8节 24000mAh 1.2M对接线 (1.0平方) 灯头的尺寸: 500*210*80mm 太阳能板尺寸: 600*350mm</p>	<p>Model: MUL-ZN50A Power: 50W Material:Aluminum body, tempered glass panel Light source: LED Lamp beads number: 50 pcs 3030 Charging time:6-10hours Full battery time: 20 hours Irradiation area:120 m² Solar panel:16V 15W Battery:6.4V*8 24000mAh 1.2m wiring cable(1 m²) Lamp head Size:500*210*80mm Solar panel Size:350*350mm Warranty: 1year</p>



太阳能人体感应路灯 | Solar Integrated Light



产品特点:

- 1.多晶太阳能板：多晶高效太阳能板，充电效率更高，长时间暴晒淋雨不会发黄；
- 2.高亮贴片灯珠：采用高亮贴片灯珠，高亮度，寿命长久；
- 3.ABS工程塑料：透光性高，光线均匀，柔和不刺眼，有效散热，使用寿命更长；
- 4.雷达感应：光控天黑灯光半亮，雷达感应人经过全亮，天亮灯灭
- 5.防水防雷：防水防雷防尘有效保护灯体，延长使用寿命，户外照明更安全；
- 6.一体化散热器：采用一体化冷锻散热器，强效空气对流设计。

Product characteristic:

- 1.Polycrystalline solar panel : polycrystalline high-efficiency solar panel, higher charging efficiency, long-term exposure to rain will not yellow.
2. High-bright patch light beads: high-bright patch light beads, high brightness, long life.
3. ABS engineering plastics: high light transmission, uniform light, soft and not glare, effective heat dissipation, longer service life.
4. Radar induction: the light control is dark and the light is half bright. The radar sensor is fully illuminated and the daylight is off.
5. Waterproof and lightning protection: waterproof, lightning and dustproof, effectively protect the lamp body, extend the service life, and make outdoor lighting safer.
6. Integrated radiator: integrated cold forging radiator, powerful air convection design.

应用场景 Application scenario :

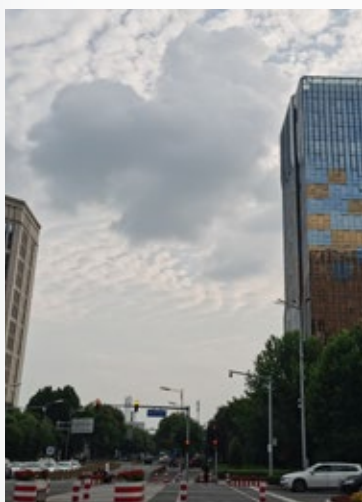

1. 道路、公路上使用 Use on roads and highways
2. 庭院墙壁上使用 Use on courtyard walls
3. 地下通道周边使用 Use around the underground passage

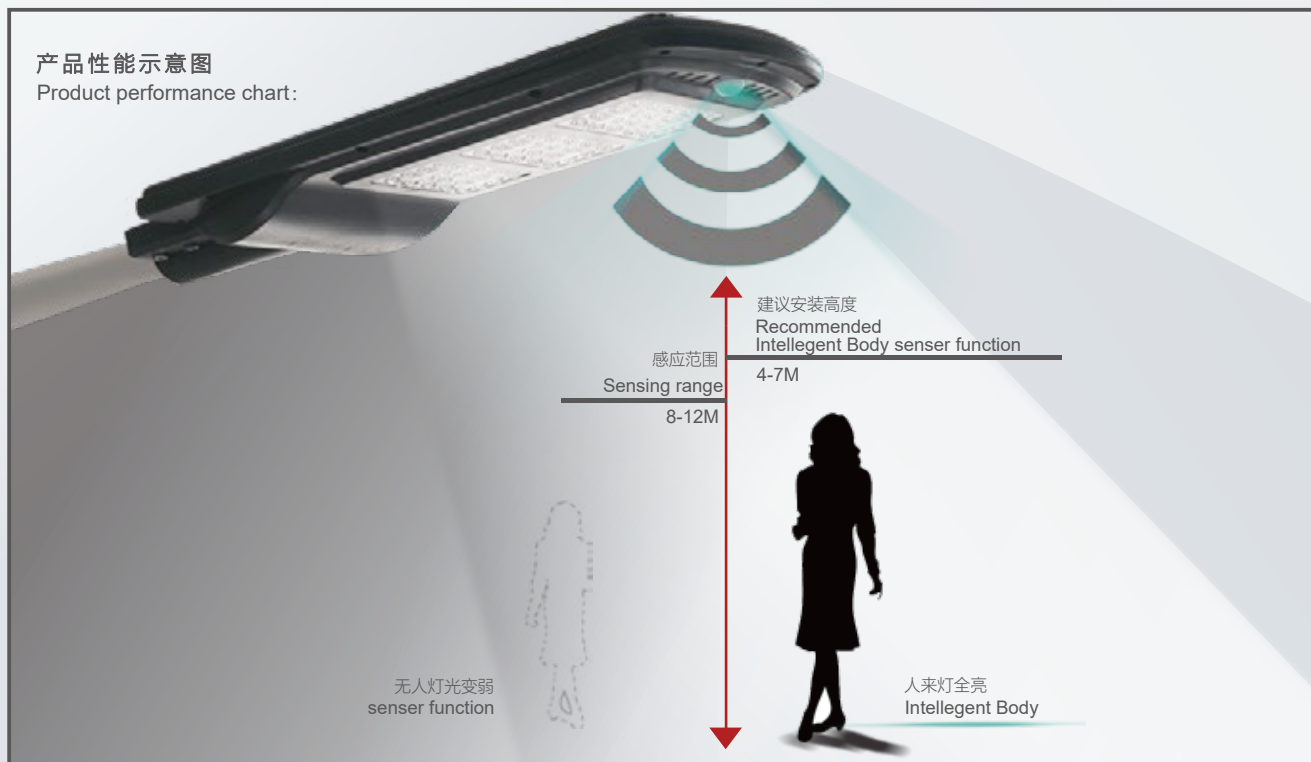

产品参数 Technical Data:

图片 Picture	内容 Content
	<p>型号: MUL-LD001-20W 功率: 20W 材质: ABS 防水等级: IP65 太阳能板: 多晶硅(6V/6W) 太阳能板尺寸: 291*171MM 灯头尺寸/重量: 410*220*70mm/1.25KG 电池: 磷酸铁锂电池6000mAh/3.2V 贴片灯珠: 20颗1W高亮灯珠 (5050灯珠) 光源: 6000K 充电时间: 6H 照明时间: 可持续照明12小时 照明面积: 40平方 工作时间: 2-3个阴雨天</p> <p>Model: MUL-LD001-20W Power: 20W Material: ABS Waterproof rating: IP65 Solar panel: polysilicon (6V/6W) Solar panel size: 291*171MM Solarlight size/weight: 410*220*70mm/1.25KG Battery: lithium iron phosphate battery 6000mAh/3.2V SMD Beads: 1W Highlight Lamp Beads 20pcs totally Light source: 6000K Charging time: 6H Lighting time: 12 hours of sustainable lighting Lighting area: 40 square Working time: 2-3 rainy days</p>
	<p>型号: MUL-LD002-40W 功率: 40W 材质: ABS 防水等级: IP65 太阳能板: 多晶硅(6V/10W) 太阳能板尺寸: 383*194MM 灯头尺寸/重量: 510*240*70mm/1.98KG 电池: 磷酸铁锂电池10000mAh/3.2V 贴片灯珠: 40颗1W高亮灯珠 (5050灯珠) 光源: 6000K 充电时间: 6H 照明时间: 可持续照明12小时 照明面积: 60平方 工作时间: 2-3个阴雨天</p> <p>Model: MUL-LD002-40W Power: 40W Material: ABS Waterproof rating: IP65 Solar panel: polysilicon (6V/10W) Solar panel size: 383*194MM Solarlight size/weight: 510*240*70mm/1.98KG Battery: lithium iron phosphate battery 10000mAh/3.2V SMD Beads: 1W Highlight Lamp Beads 40pcs totally Light source: 6000K Charging time: 6H Lighting time: 12 hours of sustainable lighting Lighting area: 60 square Working time: 2-3 rainy days</p>

产品参数 Technical Data:



型号:MUL-LD003-60W 功率: 60W
 材质: ABS
 防水等级: IP65
 太阳能板: 多晶硅(6V/12W)
 太阳能板尺寸: 497*208MM
 灯头尺寸/重量: 640*250*70mm/2.5KG
 电池: 磷酸铁锂电池12000mAh/3.2V
 贴片灯珠:60颗1W高亮灯珠 (5050灯珠)
 光源: 6000K
 充电时间: 6H
 照明时间: 可持续照明12小时
 照明面积:80平方
 工作时间: 2-3个阴雨天

Model: MUL-LD003-60W Power: 60W
 Material: ABS
 Waterproof rating: IP65
 Solar panel: polysilicon (6V/12W)
 Solar panel size: 497*208MM
 Solarlight size/weight:640*250*70mm/2.5KG
 Battery: lithium iron phosphate battery 12000mAh/3.2V
 SMD Beads: 1W Highlight Lamp Beads 60pcs totally
 Light source:6000K
 Charging time: 6H
 Lighting time: 12 hours of sustainable lighting
 Lighting area: 80 square
 Working time: 2-3 rainy days



型号:MUL-LD004-90W 功率: 90W
 材质: ABS
 防水等级: IP65
 太阳能板: 多晶硅(6V/18W)
 太阳能板尺寸: 620*240MM
 灯头尺寸/重量: 650*250*80mm/3.0KG
 电池: 磷酸铁锂电池12000mAh/3.2V
 贴片灯珠:144颗1W高亮灯珠 (5050灯珠)
 光源: 6000K
 充电时间: 6-8H
 照明时间: 可持续照明12小时
 照明面积:100平方
 工作时间: 2-3个阴雨天

Model: MUL-LD004-90W Power: 90W
 Material: ABS
 Waterproof rating: IP65
 Solar panel: polysilicon (6V/18W)
 Solar panel size: 620*240MM
 Solarlight size/weight:650*250*80mm/3.0KG
 Battery: lithium iron phosphate battery 12000mAh/3.2V
 SMD Beads: 1W Highlight Lamp Beads 144pcs totally
 Light source:6000K
 Charging time: 6-8H
 Lighting time: 12 hours of sustainable lighting
 Lighting area: 100 square
 Working time: 2-3 rainy days



型号:MUL-LD005-120W 功率: 120W
 材质: ABS
 防水等级: IP65
 太阳能板: 多晶硅(6V/20W)
 太阳能板尺寸: 650*250mm
 灯头尺寸/重量: 720*240*80mm/3.5KG
 电池: 磷酸铁锂电池15000mAh/3.2V
 贴片灯珠:192颗1W高亮灯珠 (5050灯珠)
 光源: 6000K
 充电时间: 6-8H
 照明时间: 可持续照明12小时
 照明面积:120平方
 工作时间: 2-3个阴雨天

Model: MUL-LD005-120W Power: 120W
 Material: ABS
 Waterproof rating: IP65
 Solar panel: polysilicon (6V/20W)
 Solar panel size: 650*250mm
 Solarlight size/weight:720*240*80mm/3.5KG
 Battery: lithium iron phosphate battery 15000mAh/3.2V
 SMD Beads: 1W Highlight Lamp Beads 192pcs totally
 Light source:6000K
 Charging time: 6-8H
 Lighting time: 12 hours of sustainable lighting
 Lighting area: 120 square
 Working time: 2-3 rainy days

太阳能人体感应路灯 | Solar Integrated Light

一体化太阳能路灯的工作原理:

通过光控+时控的工作模式,白天太阳能板接收光照给锂电池进行充电,当控制器检测到太阳能板的输入电压低于5V时,控制器开始给LED光源开始供电,当太阳能板的输入电压高于5V时,控制器会自动切断LED光源的输出电源,达到天黑自动亮灯,天亮自动灭灯的目的。

一体化太阳能路灯在内部配有一个人体红外感应头,晚上对各个时段的亮灯功率进行适当调整,以达到365天天亮灯的目的,常见的亮灯模式为天黑后第一阶段2小时80%的亮度,第二阶段4小时亮灯50%的亮度,第三阶段6小时30%,配置人体红外感应头的目的是当有人或者车辆经过时,LED光源可以瞬间达到原来100%亮度,100%的亮度会默认维持30秒(30秒~120秒可以设置),当人或者车辆走后恢复原来的亮度。

The working principle of integrated solar street lamp:.

Integrated solar street light in the interior is equipped with a human body infrared sensing head, evening to adjust each time lighting power, to achieve the goal of 365 days the morning light, common mode of light for the first phase 2 hours after dark 80% brightness, the second phase 4 hours the brightness of the light 50%, 30%, the third stage 6 hours configuration is the purpose of the human body infrared sensing head when people or vehicles, LED light source can instantly at the original brightness, 100% 100% of the default brightness over 30 SEC (30 seconds to 120 seconds can be set), as people or vehicles will restore the original brightness after detailed see as shown as follows.



产品参数 Technical Data:

图片 Picture	内容 Content
	<p>型号: MUL-80T 功率: 80W 材质: 铝+太阳能钢化玻璃 防水等级: IP65 太阳能板: 高效单晶电池片 (18V 85W) 产品尺寸: 1514*315*45mm 产品重量: 16.8KG (净重) 电池: 锂电池12V 50Ah 贴片灯珠: 12V 80W 最大9000LM(普瑞2630灯珠) 充电时间: 夏天阳光下6小时充满电 安装高度: 7-8M 照明时间: 每天最长亮灯时长13小时,三阶段亮灯: 有人时亮度为70%-100%, 无人时亮度为30%-50% 工作时间: 阴雨天7~10天</p> <p>Model: MUL-80T Power: 80W Material: Aluminum+Solar tempered glass Waterproof rating: IP65 Solar panel: Monosilicon (18V / 85W) Product size: 1514*315*45mm Product weight: 16.8KG (Net weight) Battery: lithium battery 12V 50Ah SMD Beads: 12V 80W maximum 9000LM (Bridgelux 2630 lamp beads) Charging time: 6-8H Installation height :7-8M Lighting time: the longest lighting time is 13 hours per day, 3-stage lighting: brightness 70%-100% (when peple pass), 30%-50% (no peple) Working time: 7-10 rainy days</p>
	<p>型号: MUL-290A 功率: 100W 材质: 铝+太阳能钢化玻璃 防水等级: IP65 太阳能板: 高效单晶电池片 (18V 90W) 产品尺寸: 1170*425*45mm 产品重量: 17KG (净重) 电池: 锂电池12V 60Ah 贴片灯珠: 12V 90W 最大9500LM(普瑞2630灯珠) 充电时间: 夏天阳光下6小时充满电 安装高度: 7-8M 照明时间: 每天最长亮灯时长13小时,三阶段亮灯: 有人时亮度为70%-100%, 无人时亮度为30%-50% 工作时间: 阴雨天7~10天</p> <p>Model: MUL-290A Power: 100W Material: Aluminum+Solar tempered glass Waterproof rating: IP65 Solar panel: Monosilicon (18V / 90W) Product size: 1170*425*45mm Product weight: 17KG (Net weight) Battery: lithium battery 12V 60Ah SMD Beads: 12V 90W maximum 9500LM (Bridgelux 2630 lamp beads) Charging time: 6-8H Installation height :7-8M Lighting time: the longest lighting time is 13 hours per day, 3-stage lighting: brightness 70%-100% (when peple pass), 30%-50% (no peple) Working time: 7-10 rainy days</p>

产品参数 Technical Data:

<p>图片 Picture</p>	<p>内容 Content</p>
	<p>型号:MUL-120T MPPT 功率: 120W 材质: 铝+太阳能钢化玻璃 防水等级: IP65 太阳能板: 高效单晶电池片 (36V 130W) 产品尺寸: 1470*425*45mm 产品重量: 24.5KG (净重) 电池: 锂电池24V 50Ah 贴片灯珠:24V 120W 最大18000LM(普瑞2630灯珠) 充电时间: 夏天阳光下6小时充满电 安装高度: 11-13M 照明时间: 每天最长亮灯时长13小时,三阶段亮灯: 有人时亮度为70%-100%, 无人时亮度为30%-60% 工作时间: 阴雨天7~10天</p> <p>Model: MUL-120T MPPT Power: 120W Material: Aluminum+Solar tempered glass Waterproof rating: IP65 Solar panel: Monosilicon (36V / 130W) Product size: 1470*425*45mm Product weight:24.5KG (Net weight) Battery:lithium battery 24V 50Ah SMD Beads: 24V 120W maximum 18000LM (Bridgelux 2630 lamp beads) Charging time: 6-8H Installation height :11-13M Lighting time: the longest lighting time is 13 hours per day, 3-stage lighting: brightness 70%-100% (when peple pass),30%-60% (no people) Working time: 7-10 rainy days</p>
	<p>型号:MUL-150T MPPT 功率: 150W 材质: 铝+太阳能钢化玻璃 防水等级: IP65 太阳能板: 高效单晶电池片 (36V 160W) 产品尺寸: 1480*530*45mm 产品重量: 26.5KG (净重) 电池: 锂电池24V 60Ah 贴片灯珠:24V 150W 最大20000LM(普瑞2630灯珠) 充电时间: 夏天阳光下6小时充满电 安装高度: 12-15M 照明时间: 每天最长亮灯时长13小时,三阶段亮灯: 有人时亮度为70%-100%, 无人时亮度为30%-60% 工作时间: 阴雨天7~10天</p> <p>Model: MUL-150T MPPT Power: 150W Material: Aluminum+Solar tempered glass Waterproof rating: IP65 Solar panel: Monosilicon (36V / 160W) Product size: 1480*530*45mm Product weight:26.5KG (Net weight) Battery:lithium battery 24V 60Ah SMD Beads: 24V 150W maximum 20000LM (Bridgelux 2630 lamp beads) Charging time: 6-8H Installation height :12-15M Lighting time: the longest lighting time is 13 hours per day, 3-stage lighting: brightness 70%-100% (when peple pass),30%-60% (no people) Working time: 7-10 rainy days</p>
	<p>型号:MUL-200T MPPT 功率: 200W 材质: 铝+太阳能钢化玻璃 防水等级: IP65 太阳能板: 高效单晶电池片 (36V 190W) 产品尺寸: 1480*690*45mm 产品重量: 29.5KG (净重) 电池: 锂电池24V 80Ah 贴片灯珠:24V 200W 最大30000LM(普瑞2630灯珠) 充电时间: 夏天阳光下6小时充满电 安装高度: 18-20M 照明时间: 每天最长亮灯时长13小时,三阶段亮灯: 有人时亮度为70%-100%, 无人时亮度为30%-60% 工作时间: 阴雨天7~10天</p> <p>Model: MUL-200T MPPT Power: 200W Material: Aluminum+Solar tempered glass Waterproof rating: IP65 Solar panel: Monosilicon (36V / 130W) Product size: 1480*690*45mm Product weight:29.5KG (Net weight) Battery:lithium battery 24V 80Ah SMD Beads: 24V 200W maximum 30000LM (Bridgelux 2630 lamp beads) Charging time: 6-8H Installation height :18-20M Lighting time: the longest lighting time is 13 hours per day, 3-stage lighting: brightness 70%-100% (when peple pass),30%-60% (no people) Working time: 7-10 rainy days</p>
 <p>Wifi+4G+Cable</p>	<p>型号:MUL-CCTV4G 80A-B-WX 功率: 80W 材质: 铝+太阳能钢化玻璃 防水等级: IP65 太阳能板: 高效单晶电池片 (18V 100W) 产品尺寸: 1290*425*45mm 产品重量: 17.5KG (净重) 电池: 锂电池12V 60Ah 贴片灯珠:12V 80W 最大8500LM(普瑞2630灯珠) 充电时间: 夏天阳光下6小时充满电 安装高度: 7-8M 照明时间: 每天最长亮灯时长13小时,三阶段亮灯: 有人时亮度为70%-100%, 无人时亮度为30%-60% 工作时间: 阴雨天7~10天</p> <p>Model: MUL-CCTV4G 80A-B-WX Power: 80W Material: Aluminum+Solar tempered glass Waterproof rating: IP65 Solar panel: Monosilicon (18V / 100W) Product size: 1170*425*45mm Product weight:17KG (Net weight) Battery:lithium battery 12V 60Ah SMD Beads: 12V 90W maximum 9500LM (Bridgelux 2630 lamp beads) Charging time: 6-8H Installation height :7-8M Lighting time: the longest lighting time is 13 hours per day, 3-stage lighting: brightness 70%-100% (when peple pass),30%-50% (no people) Working time: 7-10 rainy days</p>
	<p>型号:MUL-WZ100T A5050 MPPT 功率: 100W 材质: 铝+太阳能钢化玻璃 防水等级: IP65 太阳能板: 高效单晶电池片 (36V 110W) 产品尺寸: 1360*425*45mm 产品重量: 20.5KG (净重) 电池: 锂电池24V 30Ah 贴片灯珠:24V 100W 最大18000LM(普瑞5050灯珠) 充电时间: 夏天阳光下7小时充满电 安装高度: 9-10M 照明时间: 每天最长亮灯时长13小时,三阶段亮灯: 有人时亮度为70%-100%, 无人时亮度为30%-60% 工作时间: 阴雨天7~10天</p> <p>Model: MUL-WZ100T A5050 MPPT Power: 100W Material: Aluminum+Solar tempered glass Waterproof rating: IP65 Solar panel: Monosilicon (36V / 110W) Product size: 1360*425*45mm Product weight:20.5KG (Net weight) Battery:lithium battery 24V 30Ah SMD Beads: 24V 100W maximum 18000LM (Bridgelux 5050 lamp beads) Charging time: 7-8H Installation height :9-10M Lighting time: the longest lighting time is 13 hours per day, 3-stage lighting: brightness 70%-100% (when peple pass),30%-50% (no people) Working time: 9-10 rainy days</p>

太阳能监控路灯 | Solar Integrated Light CCTV

产品特点:

1. 太阳能监控路灯，不需要布线，太阳能供电，灯头可以选择功率大小。
2. WIFI/4G卡两种连接方式，4G卡广泛应用在再监控设备中，运行稳定。
3. 高效存储图像，APP远程观看。
4. 350°无死角监控经济实用
5. 高清夜视，高清图质。
6. 防水电池箱内置锂电池，内置太阳能控制器，有效保护电池充放电。

Product characteristic:

1. Solar monitoring street lights, no wiring, solar power supply, the lamp holder can choose the power size.
2. WIFI/4G card two connection methods, 4G card is widely used in monitoring equipment, and the operation is stable.
3. Efficient storage of images, APP remote viewing.
4. 360° no dead angle monitoring is economical and practical
5. High-definition night vision, high-definition picture quality.
6. The waterproof battery box has a built-in lithium battery and a built-in solar controller to effectively protect the battery from charging and discharging.

应用场景

Application scenario:



走廊庭院
Corridor courtyard



室外运动场所
Outdoor sports place



旅游胜地
Tourist resort



公园绿色环保照明
Green lighting in the park

适用于更多户外场景以确保周边安全性。

Suitable for more outdoor scenes to ensure surrounding safety.

产品参数 Technical Data:

图片 Picture	内容 Content
 <p>4G自动巡航 4G 360° cruise</p>	<p>型号:MUL-FCCTV4G50A-A3030</p> <ol style="list-style-type: none"> 1.材质: 铝+钢化玻璃 2.太阳能板: 18V 60W单晶太阳能板 3. LED: 50颗Bridgelux 3030 Max 5100LM 标称功率50W 4.电池: 锂电池12V 30AH 5.安装高度: 6-7m 6.放电时间: 潮湿天气5至7天可调 7.工作温度: -30°C~+60°C 8.充电时间: 7小时, 阳光充足 9.防水等级: IP65 10.照明模式: 午夜前5H 100%-30%明亮的红外运动传感器+ 5H 50%-30%照明, 直到黎明之前3H 40%-20%照明 (节能模式可延长后备阴雨天) 11.安装 距离: 25-30m <p>Model: MUL-FCCTV4G50A-A3030</p> <ol style="list-style-type: none"> 1. Material: Aluminum + Steel glass 2. Solar Panel: 18V 60W monocrystalline solar panel 3. LED : 50PCS Bridgelux 3030 Max 5100LM Nominal Wattage 50W 4. Battery:lithium battery 12V 30AH 5. Mounting Height: 6-7m 6. Discharge Time: adjustable wet weather 5 to 7 days 7. Working Temperature:-30 C~+60 C 8. Charge Time:7 Hours with good sunshine 9. Waterproof rating: IP65 10. Lighting mode: 5H 100%-30% bright lighting infrared motion sensor + 5H 50%-30% lighting before midnight and 3H 40%-20% lighting till dawn (energy saving mode to prolong backup rainy days) 11. Install the distance:25-30m
 <p>全彩 Wifi 巡航 Wifi cruise-Full Color</p>	<p>型号:MUL-FCCTV2 5Q-WIFI-200W-64G</p> <ol style="list-style-type: none"> 1.材质: 铝+钢化玻璃 2.太阳能板: 18V 60W单晶太阳能板 3.电池: 锂电池12V 20AH 输出电压: DC 12V 输入电压: DC 18V 4.安装高度: 6-7m 5.放电时间: 潮湿天气5至7天可调 6.工作温度: -30°C~+60°C 7.工作湿度15~90%RH 8.充电时间: 7小时, 阳光充足 9.防水等级: IP65 10.安装距离: 25-30m 11.CCT 3000~6500 12.CRI 80/90 13.light: 可选 <p>Model: MUL-FCCTV2 5Q-WIFI-200W-64G</p> <ol style="list-style-type: none"> 1. Material: Aluminum + Steel glass 2. Solar Panel: 18V 60W monocrystalline solar panel 3. Battery:lithium battery 12V 20AH Output Voltage: DC 12V Input Voltage: DC 18V 4. Mounting Height: 6-7m 5. Discharge Time: adjustable wet weather 5 to 7 days 6. Working Temperature:-30 C~+60 C 7. Operating Humidity 15~90%RH 8. Charge Time:7 Hours with good sunshine 9. Waterproof rating: IP65 10. Install the distance:25-30m 11. CCT 3000~6500 12. CRI 80/90 13. light:Optional

产品参数 Technical Data:

图片 Picture	内容 Content
 <p style="text-align: center;">Wifi cruise 巡航</p>	<p>型号:MUL-FCCTVQJ-WIFI-200W-64G</p> <ol style="list-style-type: none"> 1.材质: 铝+钢化玻璃 2.太阳能板: 18V 60W单晶太阳能板 3.电池: 锂电池12V 20AH 输出电压: DC 12V 输入电压: DC 18V 4.安装高度: 6-7m 5.放电时间: 潮湿天气5至7天可调 6.工作温度: -30℃~+60℃ 7.工作湿度15~90%RH 8.充电时间: 7小时, 阳光充足 9.防水等级: IP65 10.安装距离: 25-30m 11.CCT 3000~6500 12.CRI 80/90 13.light: 可选 <p>Model: MUL-FCCTVQJ-WIFI-200W-64G</p> <ol style="list-style-type: none"> 1. Material: Aluminum + Steel glass 2. Solar Panel: 18V 60W monocrystalline solar panel 3. Battery:lithium battery 12V 20AH Output Voltage: DC 12V Input Voltage: DC 18V 4. Mounting Height: 6-7m 5. Discharge Time: adjustable wet weather 5 to 7 days 6. Working Temperature:-30 C ~+60 C 7. Operating Humidity 15~90%RH 8. Charge Time:7 Hours with good sunshine 9. Waterproof rating: IP65 10. Install the distance:25-30m 11. CCT 3000~6500 12. CRI 80/90 13. light: Optional
 <p style="text-align: center;">Wifi cruise 巡航</p>	<p>型号:MUL-FCCTVQJ-WIFI-M-200W-64G</p> <ol style="list-style-type: none"> 1.材质: 铝+钢化玻璃 2.太阳能板: 18V 60W单晶太阳能板 3.电池: 锂电池12V 20AH 输出电压: DC 12V 输入电压: DC 18V 4.安装高度: 6-7m 5.放电时间: 潮湿天气5至7天可调 6.工作温度: -30℃~+60℃ 7.工作湿度15~90%RH 8.充电时间: 7小时, 阳光充足 9.防水等级: IP65 10.安装距离: 25-30m 11.CCT 3000~6500 12.CRI 80/90 13.light: 可选 <p>Model: MUL-FCCTVQJ-WIFI-M-200W-64G</p> <ol style="list-style-type: none"> 1. Material: Aluminum + Steel glass 2. Solar Panel: 18V 60W monocrystalline solar panel 3. Battery:lithium battery 12V 20AH Output Voltage: DC 12V Input Voltage: DC 18V 4. Mounting Height: 6-7m 5. Discharge Time: adjustable wet weather 5 to 7 days 6. Working Temperature:-30 C ~+60 C 7. Operating Humidity 15~90%RH 8. Charge Time:7 Hours with good sunshine 9. Waterproof rating: IP65 10. Install the distance:25-30m 11. CCT 3000~6500 12. CRI 80/90 13. light: Optional

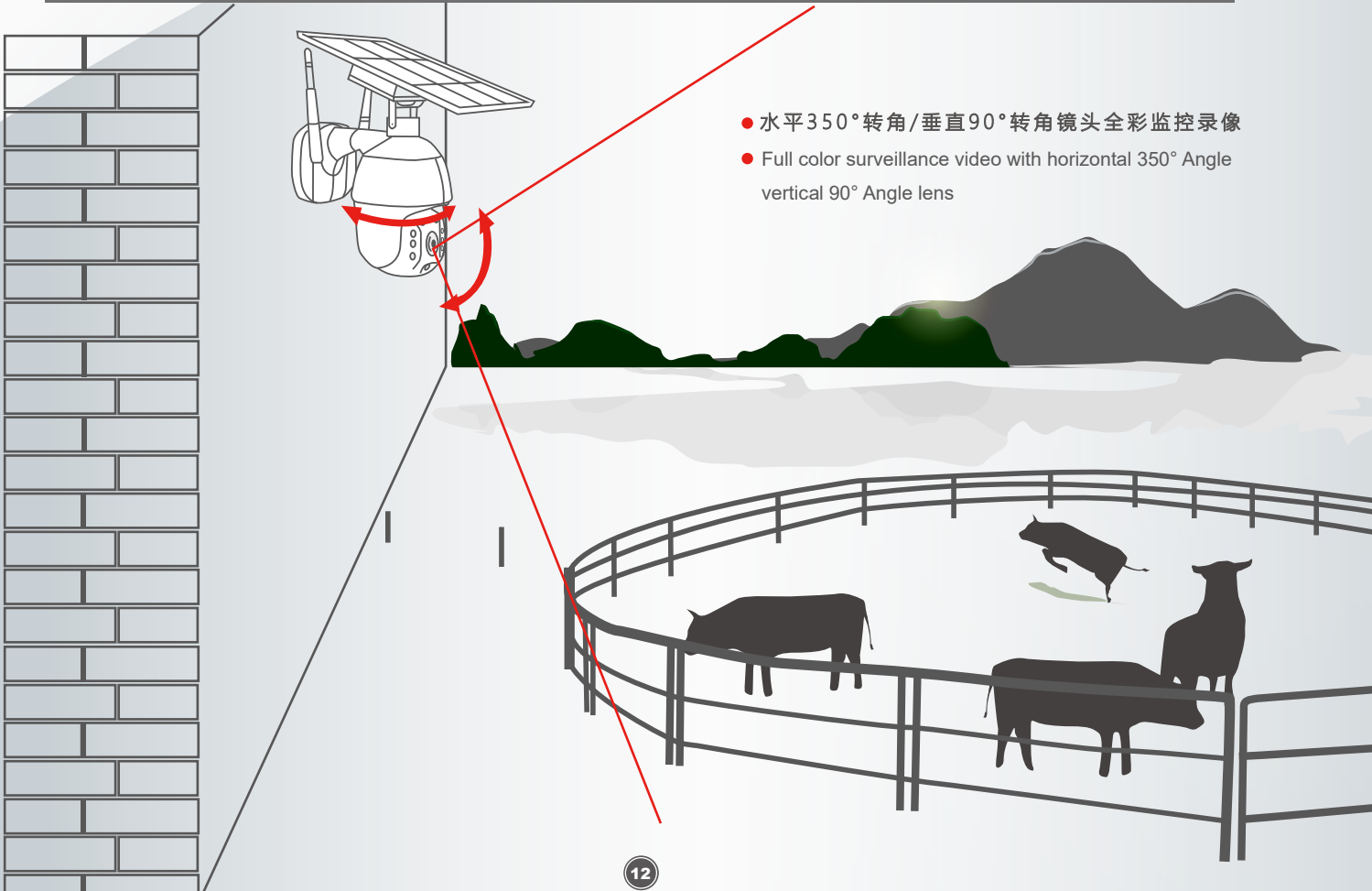

- 水平350°转角/垂直90°转角镜头全彩监控录像
- Full color surveillance video with horizontal 350° Angle vertical 90° Angle lens

太阳能投光灯 | Solar Flood Light



产品特点:

1. 优质压铸铝外壳：精工一体化压铸灯体，不易腐蚀，硬度强不易变形，使用寿命8-10年。
2. 高亮节能灯珠，晶元芯片：流明高，亮度大，光衰低，寿命长
3. 光敏感应+太阳能遥控：太阳能光控感应，白天熄灯自动充电蓄电，晚上自动亮灯。遥控器可远距离遥控调节亮度，定时，运行模式功能
4. IP65防护：高等级防水防雷，防水导线接头。

Product characteristic:

1. High-quality die-casting aluminum casing: Seiko integrated die-casting lamp body, not easy to corrode, strong hardness and not easy to deform, the service life is 8-10 years.
2. High-energy-saving lamp beads, wafer chip: high lumens, high brightness, low light decay, long life.
3. Photosensitive induction & solar remote control: solar light control induction, automatic charging and storage during daytime, and automatic lighting at night. The remote control can remotely adjust the brightness, timing, and operation mode functions.
4. IP65 protection: high-grade waterproof lightning protection, waterproof wire connector.

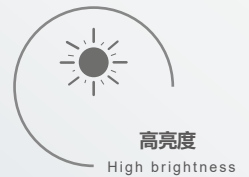
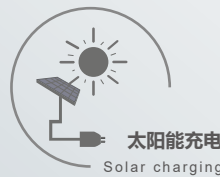
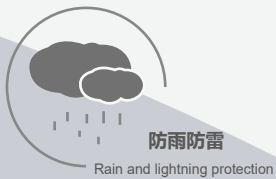

产品参数 Technical Data:

颜色：表面喷砂黑色压铸铝
Color: surface sandblasted black die-cast aluminum

配置：光控+遥控
Configuration: Light control + remote control

图片 Picture	内容 Content
	<p>型号: MUL-ZQ002-20W 功率: 20W 太阳能板: 多晶硅(6V/6W) 太阳能板尺寸/重量: 350*235*17MM / 0.94 kgs 电池: 三元锂电池5000mAh 贴片灯珠: 40珠5730瑞丰光电灯珠 光源: 6000k 材质: ABS+压铸铝 防水等级: IP65 充电时间: 6H 照明时间: 可持续照明12小时 照明面积: 60平方 灯头尺寸/重量: 180*160*48/0.88kg</p> <p>Model: MUL-ZQ002-20W Power: 20W Solar panel: polysilicon (6V/6W) Solar panel size/weight: 350*235*17MM / 0.94kgs Battery: lithium battery 5000mAh SMD lamp beads: 40 beads 5730 lamp beads Light source: 6000K Material: ABS + die-cast aluminum Waterproof rating: IP65 Charging time: 6H Lighting time: 12 hours of sustainable lighting Lighting area: 60 square Lamp head size / weight: 180*160*48/0.88kg</p>

产品参数 Technical Data:

颜色: 表面喷砂黑色压铸铝

Color: surface sandblasted black die-cast aluminum

配置: 光控+遥控

Configuration: Light control + remote control

图片 Picture	内容 Content
	<p>型号:MUL-ZQ003-30W 功率: 30W 太阳能板: 多晶硅(6V/8W) 太阳能板尺寸/重量: 370*305*17MM / 1.2 kgs 电池: 三元锂电池6000mAh 贴片灯珠:60珠5730瑞丰光电灯珠 光源: 6000K 材质: ABS+压铸铝 防水等级: IP65 充电时间: 6H 照明时间: 可持续照明12小时 照明面积:80平方 灯头尺寸/重量: 190*196*48/0.98kg</p> <p>Model: MUL-ZQ003-30W Power: 30W Solar panel: polysilicon (6V/8W) Solar panel size/weight: 370*305*17MM/1.2kgs Battery: lithium battery 6000mAh SMD lamp beads: 60 beads 5730 lamp beads Light source: 6000K Material: ABS + die-cast aluminum Waterproof rating: IP65 Charging time: 6H Lighting time: 12 hours of sustainable lighting Lighting area: 80 square Lamp head size / weight: 190*196*48/0.98kg</p>
	<p>型号:MUL-ZQ004-50W 功率: 50W 太阳能板: 多晶硅(6V/12W) 太阳能板尺寸/重量: 420*370*17MM / 1.43 kgs 电池: 三元电池16000mAh 贴片灯珠:100珠5730瑞丰光电灯珠 光源: 6000K 材质: ABS+压铸铝 防水等级: IP65 充电时间: 6H 照明时间: 可持续照明12小时 照明面积:100平方 灯头尺寸/重量: 209*240*54/1.53kg</p> <p>Model: MUL-ZQ004-50W Power: 50W Solar panel: polysilicon (6V/12W) Solar panel size/weight: 420*370*17MM/1.43kgs Battery: lithium battery 16000mAh SMD lamp beads: 100 beads 5730 lamp beads Light source: 6000K Material: ABS + die-cast aluminum Waterproof rating: IP65 Charging time: 6H Lighting time: 12 hours of sustainable lighting Lighting area: 100 square Lamp head size / weight: 209*240*54/1.53kg</p>
	<p>型号:MUL-ZQ005-100W 功率: 100W 太阳能板: 多晶硅(6V/18W) 太阳能板尺寸/重量: 600*350*17MM / 1.43 kgs 电池: 三元电池28000mAh 贴片灯珠:200珠5730瑞丰光电灯珠 光源: 6000K 材质: ABS+压铸铝 防水等级: IP65 充电时间: 6H 照明时间: 可持续照明12小时 照明面积:120平方 灯头尺寸/重量: 209*240*54/1.53 kg</p> <p>Model: MUL-ZQ005-100W Power: 100W Solar panel: polysilicon (6V/18W) Solar panel size/weight: 600*350*17MM/ 1.43kgs Battery: lithium battery 28000mAh SMD lamp beads: 200 beads 5730 lamp beads Light source: 6000K Material: ABS + die-cast aluminum Waterproof rating: IP65 Charging time: 6H Lighting time: 12 hours of sustainable lighting Lighting area: 120 square Lamp head size / weight: 209*240*54/1.53kg</p>
	<p>型号:MUL-ZQ005-200W 功率: 200W 太阳能板: 多晶硅(6V/30W) 太阳能板尺寸/重量: 350*630*17mm / 2.73 kgs 电池: 3.2v 36000mah 磷酸铁锂电池 贴片灯珠:300珠5730瑞丰光电灯珠 材质: 压铸铝+电镀反光板+钢化玻璃 防水等级: IP67 充电时间: 6小时 照明时间: 8-12小时 照明面积:120度 灯头尺寸/重量: 310*345*75/3KG</p> <p>Model: MUL-ZQ005-200W Power: 200W Solar panel: polysilicon (6V/30W) Solar panel size/weight: 350*630*17MM / 2.73kgs Battery: 3.2v 36000mAh lithium iron phosphate battery SMD lamp beads: 300 beads 5730 lamp beads Material: die-cast aluminum + Electroplated reflector + tempered glass Waterproof rating: IP67 Charging time: 6H Lighting time: 8-12 hours of sustainable lighting Lighting area: 120 square Lamp head size / weight: 310*345*75/3kg</p>

太阳能庭院灯案例 | 15
Solar Garden Light Project

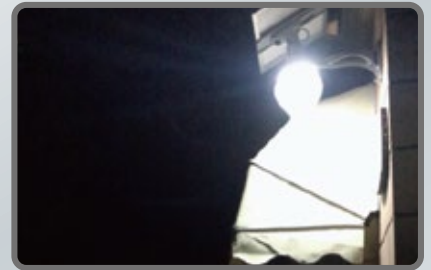
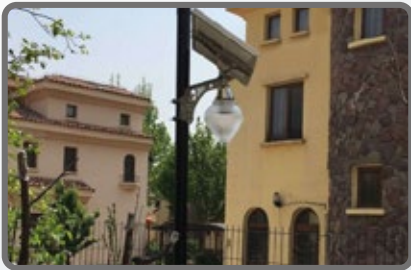

太阳能路灯案例 | 16
Solar Street Light Project

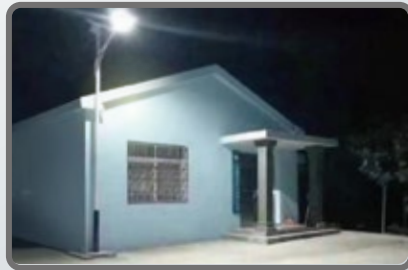

太阳能人体感应路灯案例 | 17
Solar Integrated Light Project



太阳能人体感应路灯案例 | 18
Solar Integrated Light Project



太阳能监控路灯案例 | 19
Solar Integrated Light CCTV Project



IP Camera

2020-11-01 15:55:29



太阳能投光灯案例 | 20 Solar Flood Light Project

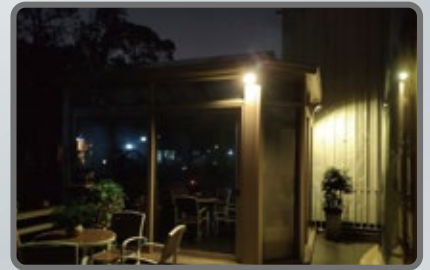

MULTIFIT

众能力电

Beijing Multifit Electrical Technology Co.,Ltd
北京众能力电科技有限公司



网址 Website: <http://www.multifitele.com>

邮箱 Email: multifit@multifitele.com

电话 Tel: 86-010-87227420 86-0754-81888658

